

7.0m²

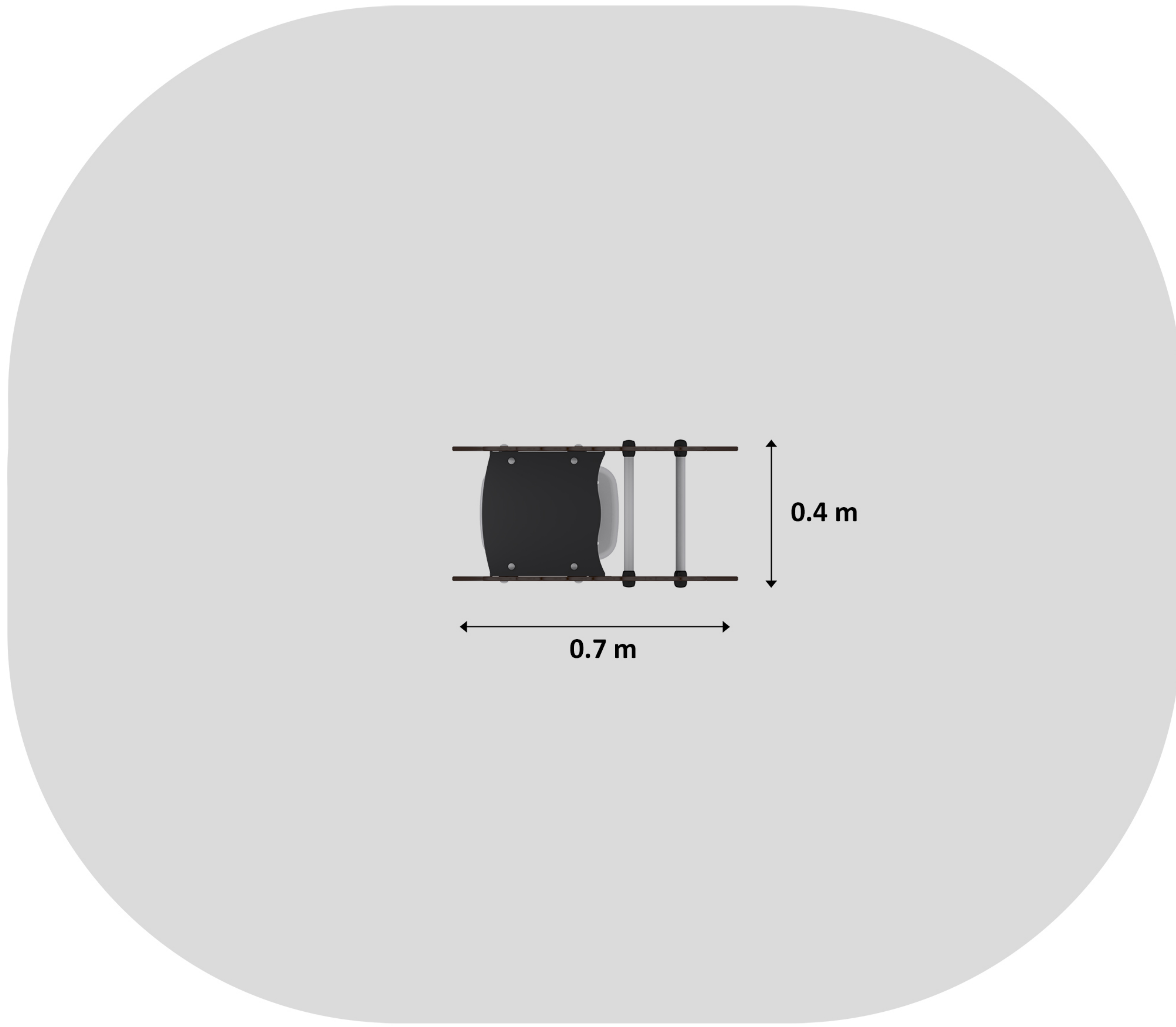

0.4 m

0.7 m

2.6 m

3.0 m