

7.0m²

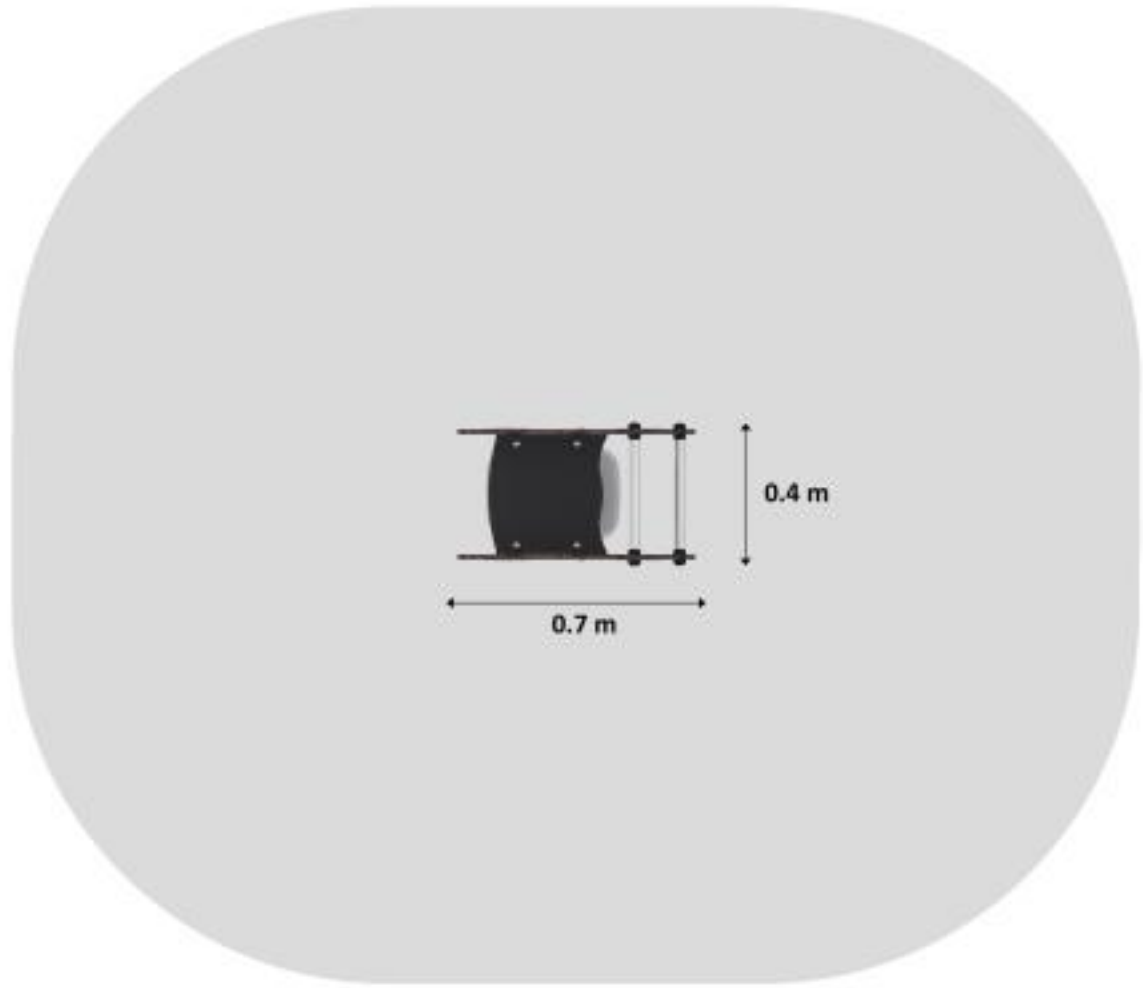

2.6 m

3.0 m

0.7 m

0.4 m